

PHOTONICS SOLUTIONS
LASERS & DETECTORS covering UV to IR

PRECISELY DESIGNED
and tailored to your application

FOR YOU
to be successful



Flow Cytometry

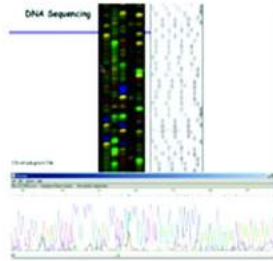

DNA Sequencing

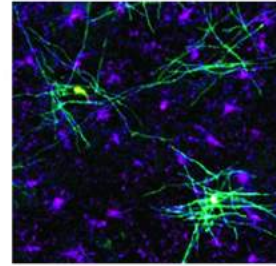

Confocal Microscopy

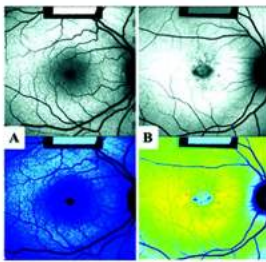

Ophthalmology

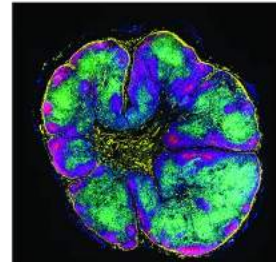

Spatial Genomics

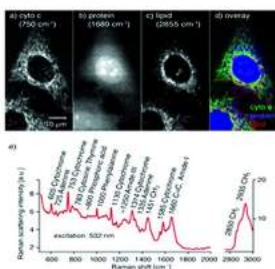

Raman Spectroscopy

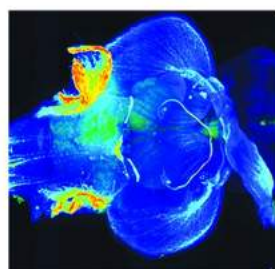

Lightsheet Imaging

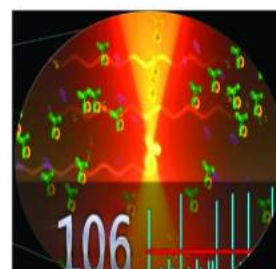

Single Molecule Detection

For Biomedical & Sensing Applications
Lasers | Detectors | OEM Engines

Pavilion Vision

Pavilion Integration Corporation (PIC), founded in 2002, is a Delaware registered Corporation with headquarters in San Jose, California, with global operation sites in Munich, Germany and Suzhou, China. The U.S. San Jose site and China Suzhou sites comprise R&D, applications, production operation, and quality teams. PIC manufactures free space and fiber coupled lasers, detectors, laser modules, and completed optical subsystems covering the UV, Visible and IR wavelength ranges for demanding biomedical and sensing industries. We chose the name Pavilion Integration Corporation for our company envisioning a place that allows us (customer and vendor) to openly discuss in mutual trust, and to work out leading edge breakthrough solutions that will enter the marketplace in disruptive ways to literally light the darkness on disease and discovery.

PIC's Photonic Integration Division works closely with customers on higher level customized integrated modules and optical sub-system assemblies. The PIC Photonic Integration Division has customer dedicated teams in Germany (Munich), Silicon Valley (San Jose), and China (Suzhou). PIC is ISO9001/13485 certified and GMP certified for medical device manufacturing.

Bring Your Applications to the Next Level of Reliability & Performance

Quality & Reliability

- » ISO9001/13485 since 2009
- » Life-time >30,000 hours
- » History of over 110,000 units shipped



Performance

- » Low Noise
- » Low Coherence
- » Low Speckle
- » Mode Hop Free
- » Back Reflection Protection
- » Excellent Beam Pointing
- » Stability over Temperature and Humidity

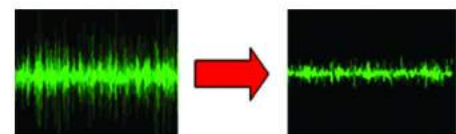



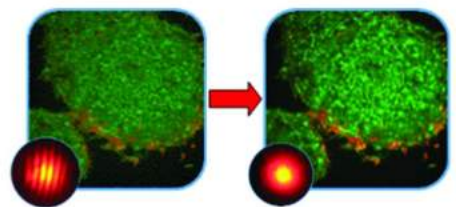

Low Noise

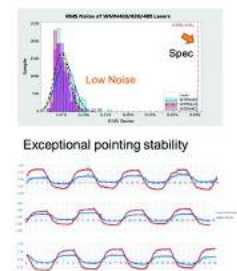
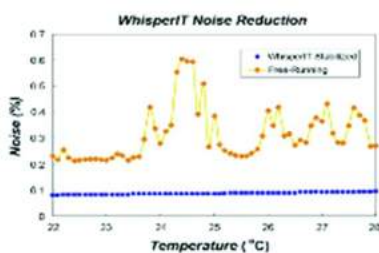

Low Coherence



WhisperIT[®] lasers utilize the company patented technology that guarantees the laser output with mode-hop free, low noise, low speckle, superior stable output power operation, and back reflection protection, under all operating conditions, while provides the custom-specific beam shape and beam delivery, at a substantially reduced cost, consistency, compact footprint, and dramatically reduced power consumption compared to conventional gas and DPSS lasers.

Ultra-Compact	Single-wavelength Free Space				Single-wavelength Excitation Module		
WMP	WMN	W	WCP	WSL	WMN Plus	WCP Plus	W Plus
							
Circular	Elliptical /Circular	Elliptical /Circular	Elliptical /Circular	Elliptical /Circular	Focus Beam Size: 15±3um*60±15um		
52*27*13mm	55*20*32mm	86*40*44mm	70*40*38mm	125*70*34mm	40*40*38mm	78*40*38mm	120*40*58mm

Single-wavelength Fiber-coupled				
W FC	WCP FC	WSL FC	WSR	WSR FCO
				
FC/APC	FC/APC	FC/APC	Circular	Collimator
86*40*44mm	70*40*38mm	125*70*34mm	125*70*34mm	125*70*34mm

Broad Range of Wavelengths and Output Powers

Single-Mode, Free-Space

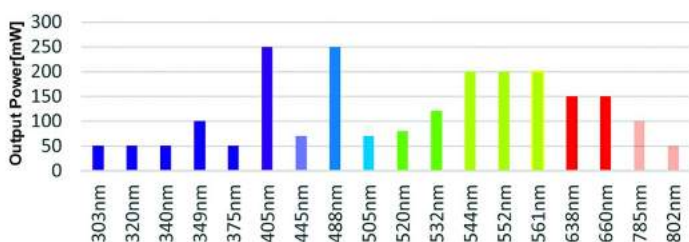

Multi-Mode, Free-Space

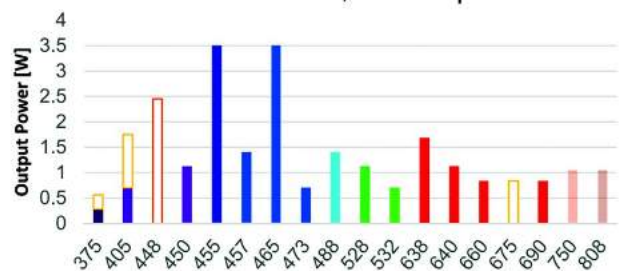

Whisper Comet® QWDM® Solid-State Detectors

are an ideal replacement to expensive PMTs, offering high QE, high sensitivity, low noise, large dynamic range, and compact space savings. SSDs can be TE-cooled for ultra-low light sensitivity and feature on-board pre-amplifier customizable to match customer's channel by channel system requirements. New enhanced sensitivity red-shift models with high quantum efficiency now available.

Single-ch SSD		
SiPM SSD	SiPM Cooling SSD	
		
350-1000nm		
53.2*29.05*19.1mm	51*25*39mm	
Multi-ch SSD		
4-ch	8-ch	Multi-ch array
		
350-1000nm		
80*49*50mm	120*49*50mm	/

- High quantum efficiency
- Blue and Red shifted options from 300-900nm
- Exact Form Fit Drop-in compatible replacement to PMT
- TE-cooled version available
- Built-in pre-amplifier
- Current or voltage output
- Multi-ch SSD standard 2, 3, up to 8-ch
- The 24, 32, 64, and 72-ch array is available upon request

WhisperIT® Lapis® Multi-Laser Series

line of high-power multi-mode and single-mode laser based optical engines include integrated built-in lasers, customizable beam shaping, and wavelength range specific detectors modules. Each Lapis® optics box undergo an extensive manufacturing process to ensure robust beam pointing stability over temperature and humidity ensuring long-life in the field.

Lapis Multi-laser Free Space		Lapis Multi-laser Fiber Coupled	
2/3-laser	4-laser	3/4-laser	3/4-laser
Collinear or evenly spaced multi laser beams		Single-Mode PM Fiber	Single-Mode PM Fiber
Focus Beam Size: 15±3um * 60±15um		FC/APC	Collimator
130*176*60mm	155*180*60mm	136*90*73mm	270*160*50mm

Lapis Multi-laser High Power				
1/2-laser	5-laser	7-laser (up to 9)	5/7-LED	Bright Light
400um/450*150um 0.22NA	400um/800um/1000um 0.22/0.39NA	400um/800um/1000um 0.22/0.39NA	400um/800um/1000um 0.22/0.39NA	400um/800um/1000um 0.22/0.39NA
SMA; FC/APC	SMA; FC/APC	SMA; FC/APC	SMA; FC/APC	SMA; FC/APC
320*180*110mm	360*145*240mm	320*430*160mm	360*145*240mm	125*107*57mm

Nominal Optical Performance

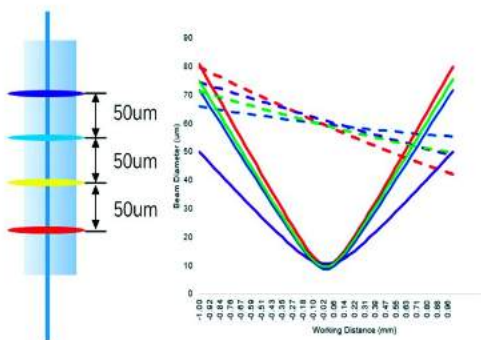

Uniformity

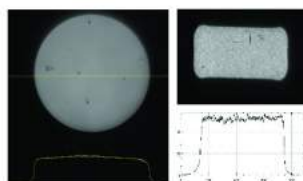

Laser Broad Range of Wavelengths and Output Powers

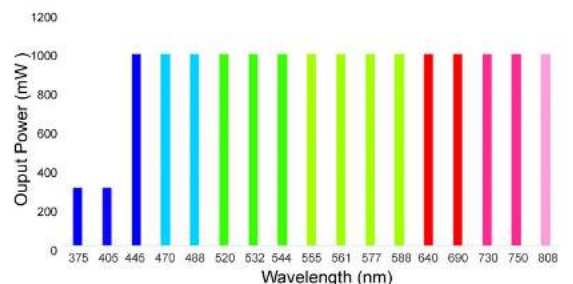

WhisperIT® Shiva® Multi-Laser Series

The Shiva® series is a pre-aligned multi-laser platform, ideally suited for biophotonics (cytometry, fluorescence, microscopy, etc.) and medical imaging in cellular biology. These applications require a flexible laser source that provide several wavelengths from one axis output or one optical fiber. Available with up to 7 different wavelengths from UV to IR:

Shiva Multi-Laser Free Space		
2/3-laser	5-laser	6/7-laser
		
Focus Beam Size: 15±3µm * 60±15µm		
405nm/488nm/638nm (532nm/561nm Optional)	405nm/488nm/561nm/638nm + UV or nIR	6-laser +1 UV

- Standard 2- or 3-laser wavelengths
- Full-time ultra-low noise
- Individual serviceable laser channel
- Pre-aligned whole optical plate
- Collinear or evenly spaced multi-laser beams
- Custom focus beam

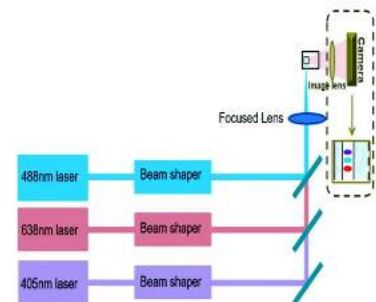

- Multi 5-laser excitation module
- Multi 6+1 laser excitation module
- Full-time ultra-low noise
- Ultra-compact structure
- Pre-aligned whole optical plate
- Custom focused beam

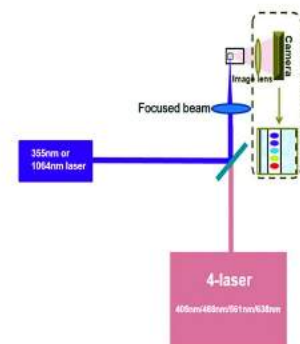

BASOE™ The Ultimate Complete Photonics Solution

The optical engine is designed with integrated excitation module, signal collection and SiPM detectors, receiving optics, filters, sample capillary or cartridge or sample flow cell.

BASOE Optical Engine			
1-laser + Spectrometer	1-laser 4-ch	2-laser 6/8-ch	3-laser 10/13-ch
			
1st-Gen DNA Sequencing	POCT / FCM	FCM / Multi-plexing	FCM / Multi-plexing
L*W*H: 163*73*57mm	L*W*H: 100*54*54.5mm	L*W*H: 300*300*80mm	L*W*H: 300*300*80mm

- Standard availability: 1-laser 4-ch for POCT Specifically; 2-laser 6/8-ch; 3-laser 10/13-ch. 4-laser & other options available.
- Integrated optical engine including excitation, signal collection and detector receiving optics, filters, sample cartridge or sample flow cell.
- Collinear or evenly spaced multi laser beams at flow cell or capillary or sample cartridge.
- Integrated multi-ch receiver module.

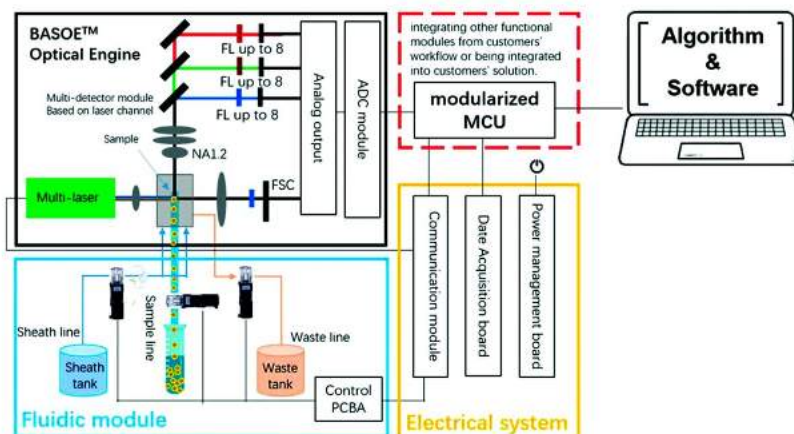

PHOTONICS SOLUTIONS

LASERS & DETECTORS covering UV to IR

PRECISELY DESIGNED

and tailored to your application

FOR YOU

to be successful



USA HeadQuarter

9765 Rolling Rock Ct

Reno, NV 89521

Tel. +1 408 859 3701

Sales email: sales@pavilionintegration.com

Technical support: support@pavilionintegration.com

USA

2528 Qume Drive, Suite 1,

San Jose CA 95131 U.S.A.

Tel: +1 408 453-8801

Europe

Am Soeldnermoos 17

85399 Hallbergmoos, Germany

Tel. +49 178 35 98089

China

Building 22#, (North Wing),

Gangtian Industrial Park

No. 99 Gangtian Road

Suzhou Industrial Park, Suzhou City,

Jiangsu, P. R. China 215021

地址：苏州工业园区港田路99号港田工业坊22栋北

Tel: +86 512 62625925